

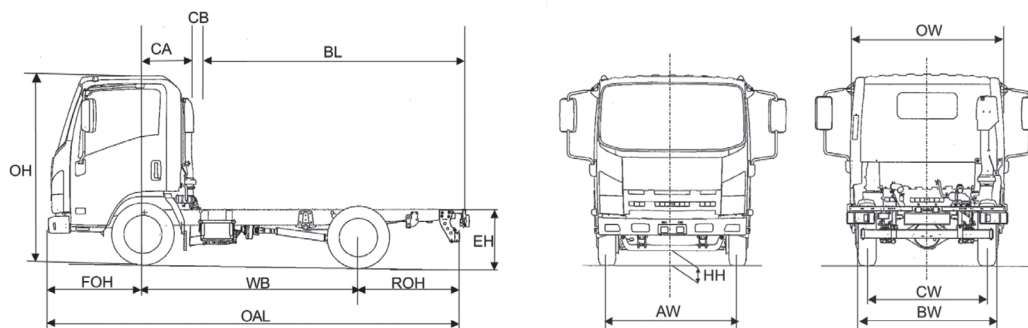

specifications:

Isuzu 'Grafter' N35.125(S)

3.5T GVW / EURO 6d Temp WLTP 4x2 rigid single rear wheels



Pictures shown are for illustration purposes only.

Axle weights (kg)			
UK maximum Vehicle Weights (kg)	GVW	3500	3500
	GTW*	7000	7000
UK Axle design weights (kg)	Front	1900	1900
	Rear	2000	2000

Weights (kg)			
Cab type		day	day
Wheelbase	WB	2500	3360
Vehicle Mass Unladen	Front	1285	1290
	Rear	465	505
Total		1750	1795
GVW		3500	3500
Body & Payload Allowance		1750	1705
Max. Permissible Trailer Weight*		3500	3500

Dimensions (mm)			
Overall Length to chassis end	OAL	4710	6015
Overhang - Front	FOH	1100	1100
Overhang - Rear	ROH	1110	1555
Cab Gap	CB	130	130
C/L Front Axle to Rear of Cab	CA	463	463
Recommended Body Length	BL	3200	4500
Chassis Frame Width		700	700
Recommended Body Width		1945	1945
Recommended Maximum Body Width		2275**	2275**
Cab Width	OW	1770	1770
Overall Height (Unladen)	OH	2145	2145
Chassis Height (Unladen)	EH	730	730
Minimum Road Clearance	HH	195	195
Track - Front	AW	1395	1395
Track - Rear	CW	1395	1395
Rear Axle Width	BW	1645	1645

*Tachograph regulations may apply

**Wide mirror arms apply at extra cost

1. Unladen weights excludes driver and fuel, includes 80% AdBlue®. Includes spare wheel + carrier (Tolerance +/- 3%). Spare wheel and carrier 38kg.
2. Body lengths are given as a guide only. Bodybuilders are responsible for ensuring all legal requirements are met.
3. Maximum body lengths are calculated to remain within the overhang ratio of 60% of the wheel base. Cab gaps may vary.
4. Isuzu Truck (UK) Ltd. shall have no liability whatsoever should the information supplied have incorrect data, descriptions or illustrations.

N35.125(S) WLTP Mechanical Specification (standard equipment)

EURO 6d Temp

POWER & TORQUE CHASSIS DETAILS

Engine

Make & model: RZ4E – Isuzu turbo intercooled DOHC 4 cylinder diesel. Lean NOx trap. DPD & SCR.

Bore x stroke: 80 x 94.4mm

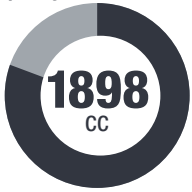
Capacity:  **1898 CC**

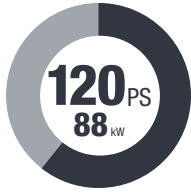
Max Power:  **120 PS**
88 kW

at 3200rpm

Transmission

Make & model: Isuzu 6 speed manual synchromesh MVC6W overdrive.

Ratios: 1st - 4.942; 2nd - 2.686; 3rd - 1.527; 4th - 1.000; 5th - 0.796; 6th - 0.634; Reverse - 4.597

Rear Axle Ratio: 4.777:1

Clutch

Type: 275mm diaphragm type with hydraulic actuation.

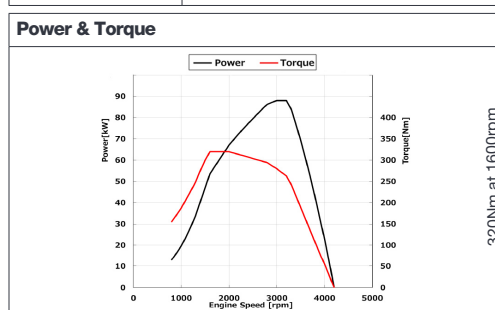

Electrical

Type: 1 x 12V 540CCA 70Ah battery with 12V/150A alternator.

Tyres/Wheels

Tyres: 205/75 R16 radial.

Wheels: 5.50J x 16, 6-stud.

Spare: 1 x wheel and tyre.

Frame

Type: Parallel ladder type channel section straight side rails, riveted upper flange.

Axles

Front: Independent type.

Rear: Banjo fully floating.

Suspension

Front: Double wishbone and transverse parallel leaf suspension with hydraulic shock absorbers.

Rear: Semi-elliptical steel suspension with hydraulic shock absorbers.

Brakes

System: Vacuum servo assisted hydraulic dual line with ABS, EBD (electronic brake distribution), EVSC (electronic vehicle stability control), ASR (anti slip regulation).

Front: 265mm ventilated discs with asbestos free pads.

Rear: 290mm drums with asbestos free linings.

Park: Mechanical drum brake rear of transmission.

Fuel Tank

Capacity:  **68 LITRES**

AdBlue®:  **10 LITRES**

CAB FEATURES

Cab Exterior

Type: Hexapod, white (standard) or metallic grey (option), all-steel.

Features:  Manual tilt to 45 deg. Tinted windscreen. Chrome radiator grille. Plastic resin non-slip entry steps. 90 deg. opening doors. Zinc galvanised frame structure. Steel reinforced composite front bumper with fog and daytime running lamps. Two halogen head lamps with indicators. Front mudguards with spray suppression. Keyless door entry and immobiliser.

Cab Interior

Features:  Flame-resistant interior trim. Vinyl floor matting. Pillar mounted entrance grab handles both sides. Driver & passenger SRS airbags.

Seats (cloth)

Features:  Driver's fully adjustable suspension seat with head restraint. Dual passenger seat with folding back. Driver and outer passenger retractable diagonal seat belts with pre-tensioner. Centre seat lap belt.

Vision

Features:  Large foldable mirrors. Interior rear view mirror on collapsible mounting. Driver and passenger sun visors. Deep cut side windows to reduce blind spots. Electric windows with driver control and lock.

Steering

Features: Rack and pinion with full integral hydraulic power assistance. Tilt and telescopic steering column.

Instruments

Features:  Speedometer with odometer & trip. Rev counter. Fuel gauge. Engine coolant temperature. Multi-information display provides information on servicing, emissions and fuel economy. AdBlue® level. DPD operation. Calendar. Clock.

Switches & Electrical

Features:  Combination stalk incorporating headlamps, indicators, fog lamp, washers and wipers. Steering wheel horn. Headlamp levelling. Engine quick warm-up. Central locking. Cigarette lighter. DPD, EVSC and ASR control. Hazard warning lights. Kenwood DAB radio with Bluetooth (Sat Nav option available).

Warning/Indicator Lamps

Features:  Battery charge. Oil pressure. Low fuel. Glow plug operation. High beam and indicators. Park brake warning. Fuel/water separator. Check engine. Engine over heat. EVSC. ABS. Front and rear fog lights. Seat belt warning. Brake fluid level. SRS air bag. Brake vacuum loss.

Tool Kit

Features: Jack with a small selection of hand tools.

SAFETY & SECURITY

R29 cab strength:	Complies with ECE-R29 cab strength standard.
Central locking:	Central locking with remote keyless entry and immobiliser.
Rear bumper:	Steel rear under run bar.
Seatbelts:	Red diagonal and lap belts.

WARRANTY

All chassis cabs come with a 3 year unlimited mileage warranty and roadside assistance as standard. Terms and conditions apply.

Isuzu-backed Repair and Maintenance contracts available upon request.

For further information please contact your local dealer or phone us direct:

01707 282930 | www.isuzutruck.co.uk

